

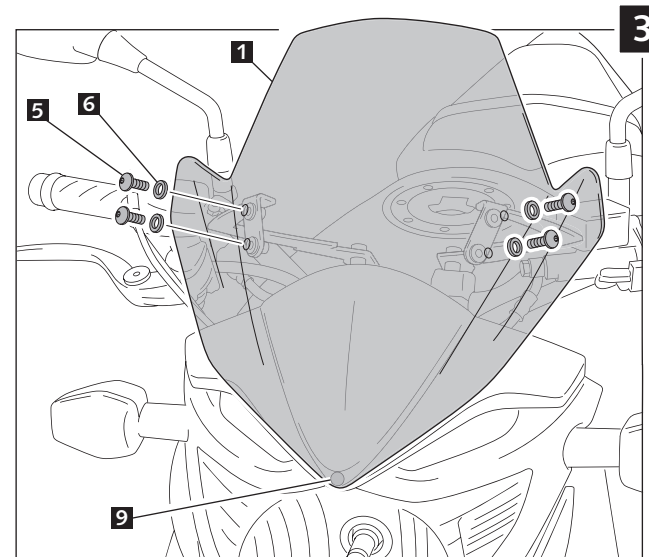

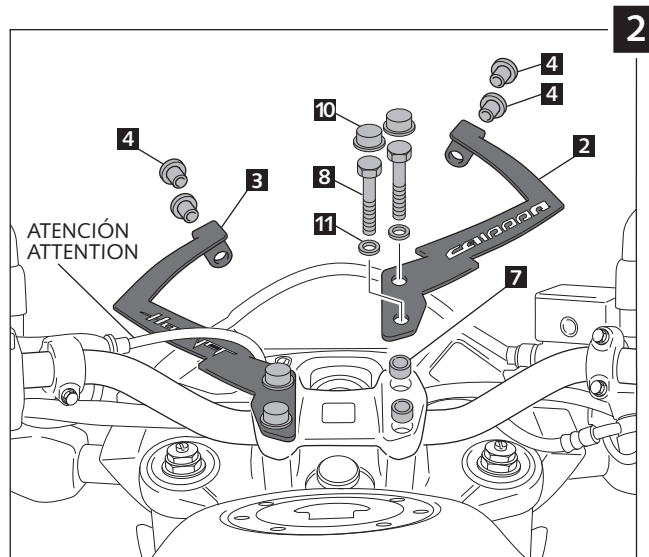

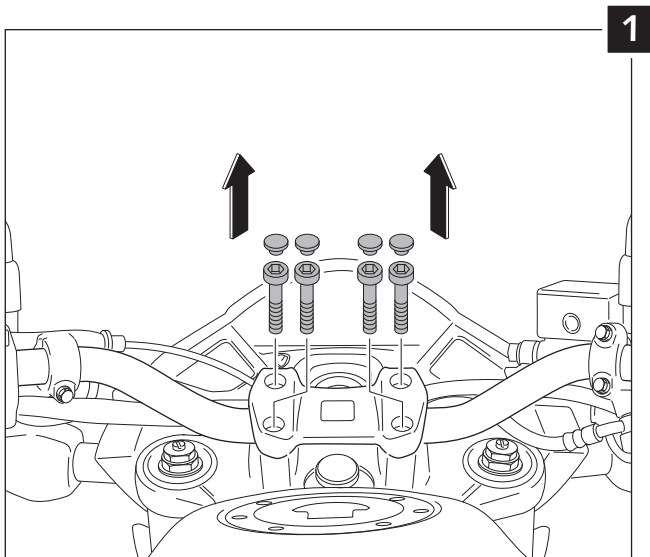







CARENABRÍS ADAPTABLE A - WINDSHIELD ADAPTABLE TO HONDA HORNET CB600F 2011

Ref.: 5644



ID.	DESCRIPCIÓN	DESCRIPTION	QTY.
1	 Pantalla	Screen	1
2	 Soporte metálico derecho	Right metal support	1
3	 Soporte metálico izquierdo	Left metal support	1
4	 Silemblock M5 (se suministra montado en la pieza nº2-3)	M5 well nut (supplied already mounted on the piece nº2-3)	4
5	 Tornillo Allen M5x16 ISO 7380	M5x16 ISO 7380 allen screw	4
6	 Arandela nylon Ø5XØ11x1	Ø5XØ11x1 nylon washer	4
7	 Casquillo Ø ext.14 x Ø int.8,5x4	Arrowhead Ø outer14 x Ø inner 8,5x4	4
8	 Tornillo hexagonal M8x45 DIN 912	M8x45 DIN 912 hexagonal screw	4
9	 Separador de silicona Ø12,7x3,5	Ø12,7x3,5 silicone delimiter	1
10	 Caperuza plana M8	M8 nut cover	4
11	 Arandela M8	M8 washer	4