

CÚPULA ADAPTABLE A - SCREEN FOR - WINDSCHUTZSCREIBE FÜR
HONDA CBR 500R '13-

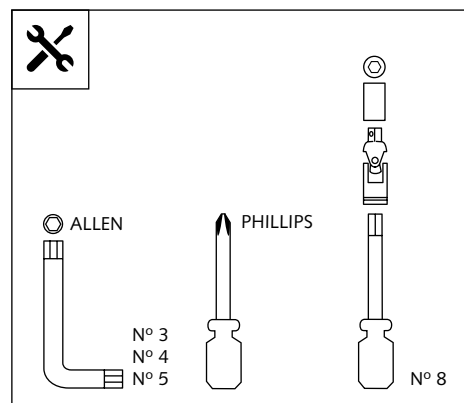

Ref.: 6479



<p>1 persona 1 person</p>	<p>30 min</p>	Fácil - Easy
		Media-Intermediate
		Difícil-Difficult

ID	PIEZA / PART	DESCRIPCIÓN	DESCRIPTION	QTY	REF.
1		Cúpula	Screen	1	6479A/C/F/H/N/R/V/NM3
2		Tornillo Allen M5x16 Ø11 ISO 7380	M5x16 Ø11 ISO 7380 Allen screw	2	TORNI-I7380-493

CÚPULA ADAPTABLE A - SCREEN FOR - WINDSCHUTZSCREIBE FÜR
HONDA CBR 500R '13-

INSTRUCCIONES DE MONTAJE - MOUNTING INSTRUCTIONS - MONTAGEANLEITUNG

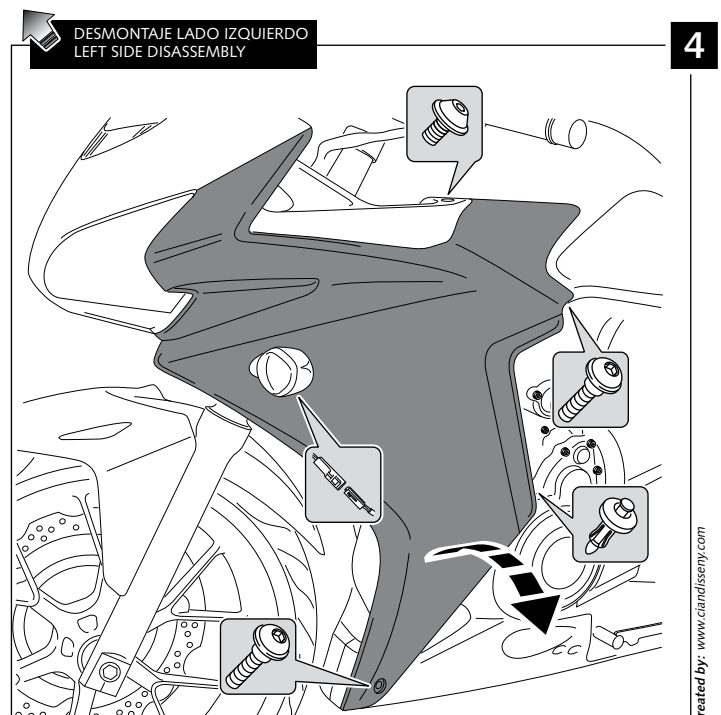
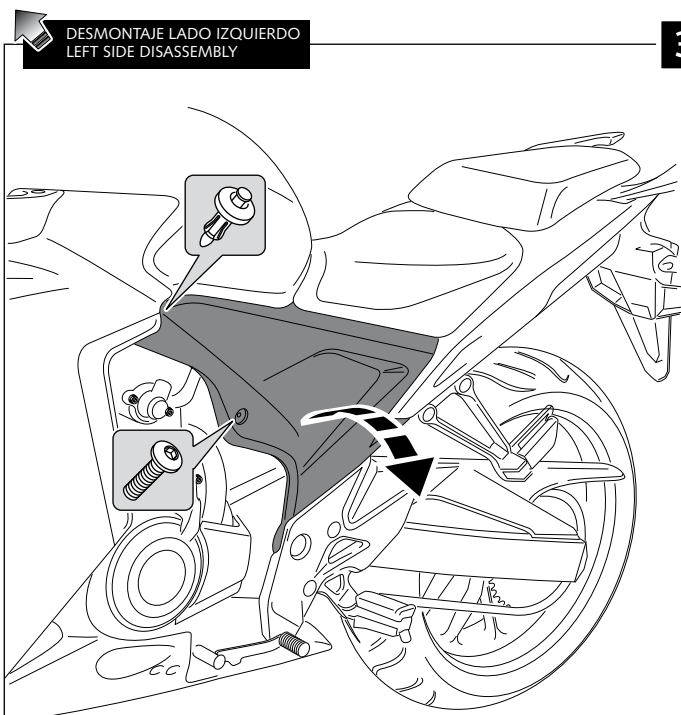
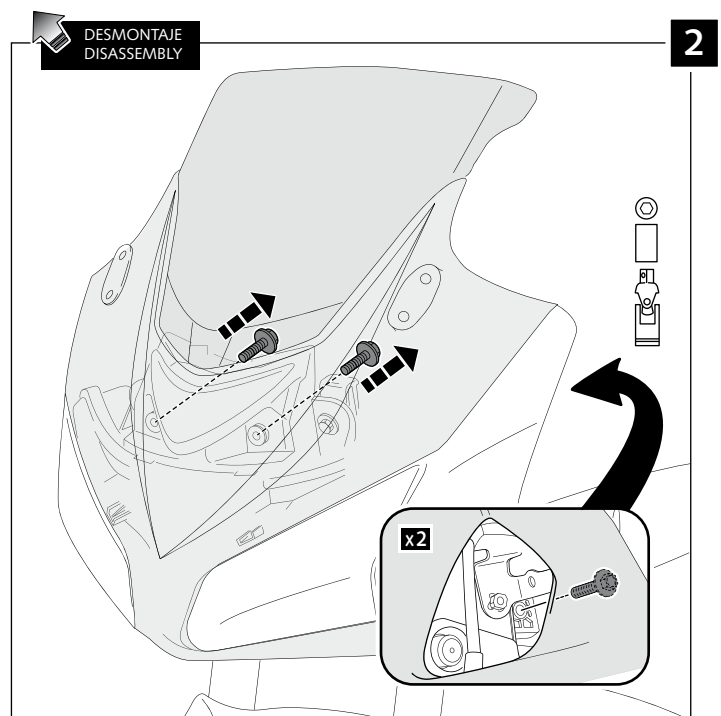
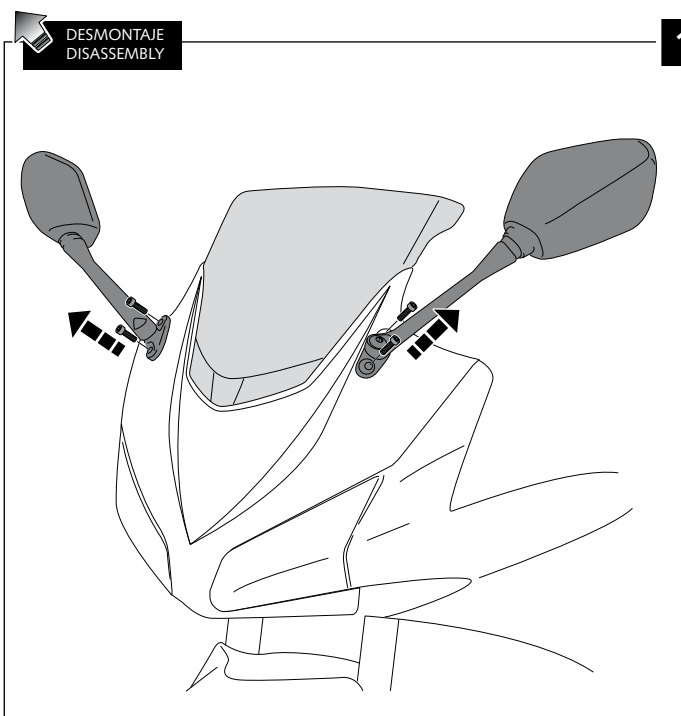

CÚPULA ADAPTABLE A - SCREEN FOR - WINDSCHUTZSCREIBE FÜR
HONDA CBR 500R '13-

INSTRUCCIONES DE MONTAJE - MOUNTING INSTRUCTIONS - MONTAGEANLEITUNG

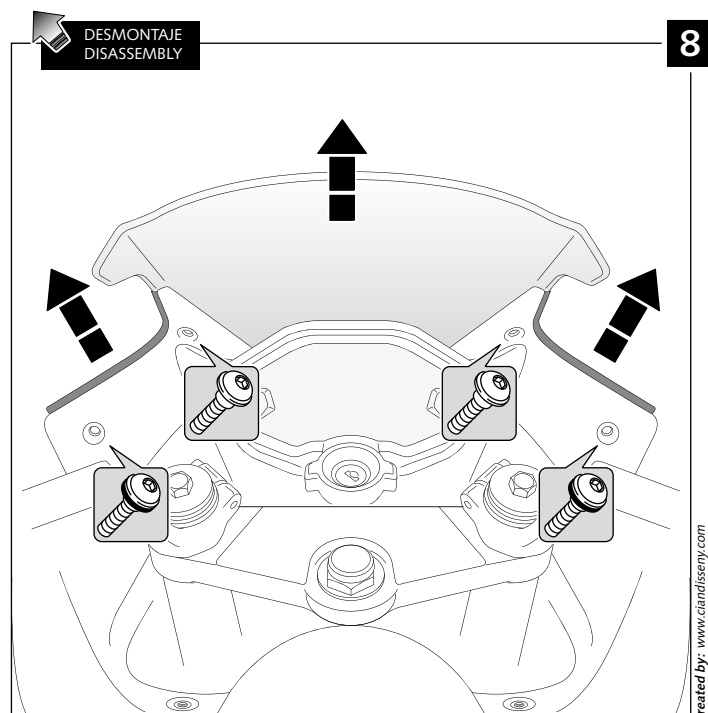
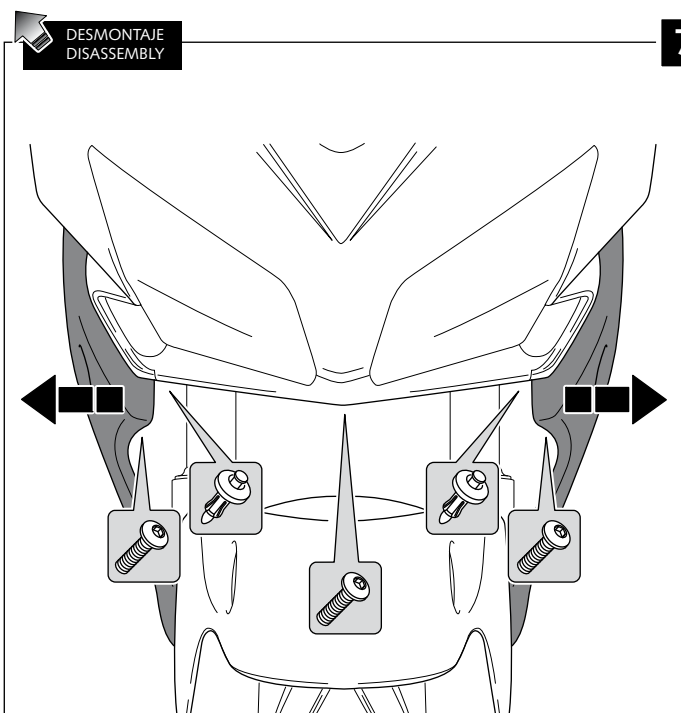
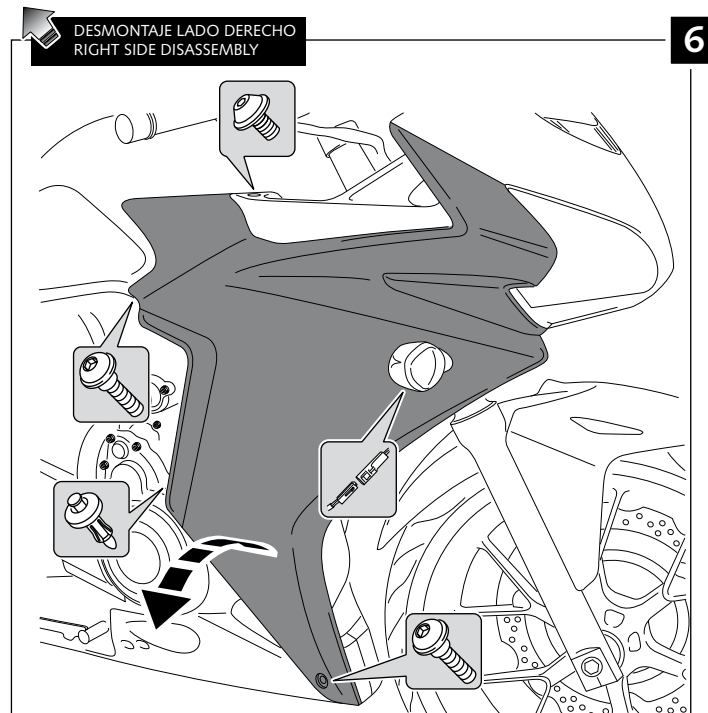
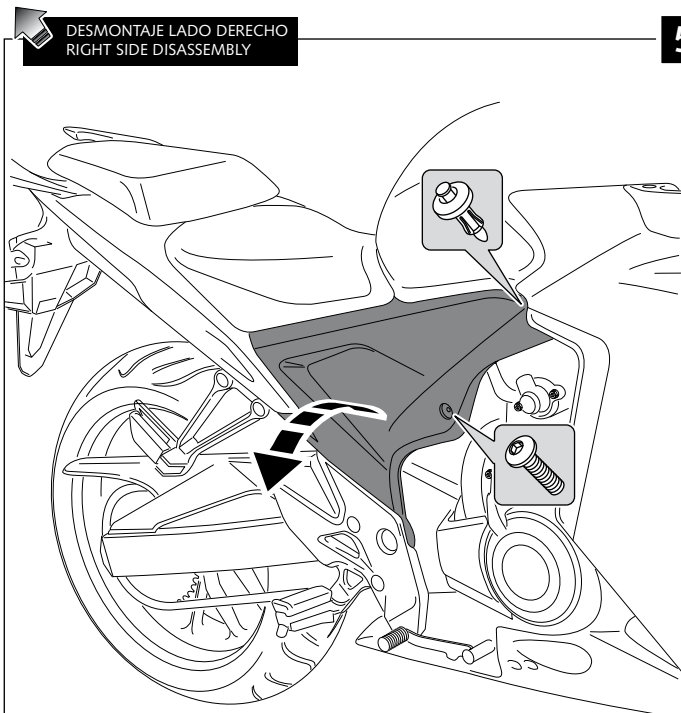

CÚPULA ADAPTABLE A - SCREEN FOR - WINDSCHUTZSCREIBE FÜR
HONDA CBR 500R '13-

INSTRUCCIONES DE MONTAJE - MOUNTING INSTRUCTIONS - MONTAGEANLEITUNG

